



User Manual



EVT800-B

Envertech Corporation Ltd.

Tel: +86 21 6858 0086

Web: www.envertec.com

Email: info@envertec.com

Add: No.138, Xijunhuan road, Minhang District, Shanghai, China

Content

1.	Important Safety Information.....	1
1.1	Read it First	1
1.2	Safety Instructions	1
2.	Envertech Microinverter System	1
2.1	How it Works	2
2.2	Monitoring Device EnverBridge.....	2
2.3	Optimal Reliability.....	3
2.4	Simple Design.....	3
3.	Product Information.....	3
3.1	Overview	3
3.2	Major Characteristics.....	3
3.3	Datasheet.....	3
4.	Preparation.....	4
4.1	Packing Checklist.....	4
4.2	Product Description	5
4.3	Further Information	5
4.4	Symbols on Inverter	5
4.5	Accessories.....	6
5.	Microinverter System Installation.....	6
6.	Debugging and Operating.....	13
6.1	Energize the System.....	13
6.2	Microinverter Operation.....	13
7.	Troubleshooting and Maintenance	13
7.1	LED Status Indications and Error Reporting.....	14
7.2	Troubleshoot an Inoperable Microinverter.....	14
7.3	Disconnect Microinverters from PV Modules	15
8.	System Diagram	15
9.	Recycling and Disposal	16
10.	Contact	16

1. Important Safety Information

1.1 Read it First

This manual contains important instructions for the installation and maintenance of the EVT800 microinverter.

To reduce the risk of electrical shock, and to ensure safe installation and operation of the microinverter, the following safety symbols appear throughout this document to indicate dangerous conditions and important safety instructions.



DANGER

DANGER indicates a hazardous situation which, if not avoided, will result in death or serious injury.



WARNING

WARNING indicates a hazardous situation which, if not avoided, can result in death or serious injury or moderate injury.



NOTICE

NOTICE indicates a situation that can result in property damage, if not avoided.

1.2 Safety Instructions

- Do not use Envertech equipment in a manner not specified by the manufacturer. Doing so may cause death or injury to persons, or damage to equipment.
- Be aware that only qualified personnel should install or replace the Envertech microinverters and the cables and accessories.

- Do not attempt to repair the Envertech microinverter; it contains no user-serviceable parts. If it fails, contact Envertech customer service to start the replacement process. Tampering with or opening the Envertech microinverter will void the warranty.
- If the AC cable on the microinverter is damaged or broken, do not install the unit.
 - Before installing or using the Envertech microinverter, read all instructions and cautionary markings in the technical description and on the Envertech microinverter system and the PV equipment.
- Connect the Envertech microinverter to the utility grid only after you have completed all installation procedures and received approval from the electric utility company.
- Please be kindly note that the Envertech microinverter itself is a heat sink. Under normal operating conditions, its temperature is 20°C above ambient, but under extreme conditions, the microinverter can reach a temperature of 90°C.
- Do not disconnect the PV module from the Envertech microinverter without rusty disconnecting AC power.

2. Envertech Microinverter System

The Envertech microinverter system is an on-grid microinverter system with world-top-class technology. This manual give details about the safe installation and operation of the Envertech microinverter.

The three key elements of an Envertech microinverter system include:

- EVT800 microinverter: Converting the DC of the PV module into AC



- EnverBridge (Optional): monitoring and protecting PV system.



- EnverPortal: <http://www.envertecportal.com>



- EnverView: IOS, Android App

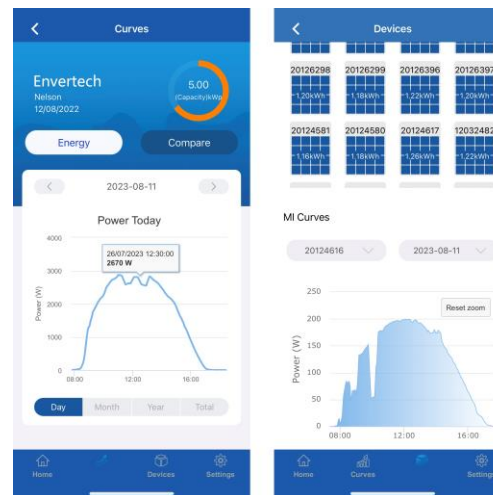

You can view the real-time data from a web browser or Envertech app.

This integrated solar system maximizes energy harvest, increases system reliability. Simplifies design, installation and management.

2.1 How it Works

The Envertech microinverter maximizes energy production from your photovoltaic (PV) array. Each Envertech microinverter is individually connected to one PV module in your array. This unique conjunction means that an individual Maximum Peak Power Point Tracker (MPPT) controls each PV module. This ensures that the maximum power available from each PV module is exported to the utility grid regardless of the performance of the other PV modules in the array. That is, although individual PV modules in the array may be acted by shading, soiling, orientation, or PV module mismatch, the Envertech microinverter ensures top performance for its associated PV module. The result is maximum energy production from your PV system.

2.2 Monitoring Device: EnverBridge

Once you install EnverBridge and have it connected to your broadband router or modem, Envertech microinverters automatically begin to report to EnverBridge's

server. EnverBridge monitoring system presents both real-time and history performance data.

2.3 Optimal Reliability

Microinverter systems are inherently more reliable than traditional inverters. The distributed nature of a microinverter system ensures that there is no single point failure in the PV system. Envertech Microinverters are designed to operate at full power at ambient temperatures as high as +65 °C (150 °F). The microinverter casing is designed for outdoor installation and complies with the IP67 protection level.

Note: To ensure optimal reliability and to meet warranty requirements, the EVT800 microinverter must be installed according to the instructions in this manual.

2.4 Simple Design

PV systems using Envertech microinverters are very simple to design and install. You can install a combination of PV modules of any type, at any orientation and in any quantity. You won't need to install cumbersome traditional inverters. Each microinverter can be quickly mounted on the PV rack, directly beneath each PV module. Low voltage DC wires connect from the PV module directly to the co-located microinverter, eliminating the risk of personnel exposure to dangerously high DC voltage.

3. Product Information

Note: For optimum reliability and to comply with warranty conditions, the EVT800 microinverter must be installed according to the instructions in this manual.

3.1 Overview



3.2 Major Characteristics

Envertech microinverters have the following characteristics which make Envertech microinverters “Highly Efficient, Highly Reliable, Highly Cost Effective”.

Low DC input voltage.

Wide MPPT voltage range ensures high yield under various weather conditions. High MPPT accuracy ensures minimum power loss during converting. Complete set of protective functions.

Also, the following protective functions are integrated into Envertech microinverters. Internal overvoltage/undervoltage protection

Faulty grounding protection Grid monitoring.

Current monitoring in grounding DC current monitoring.

EVT800 can be adapted to almost all modules. Before installation, please check the parameters of the microinverters and modules to ensure that they are compatible.

3.3 Datasheet

Model	EVT800
Input Data (DC)	
Recommended Input Power Range (STC)	(180W~550W+)*2
Max. DC input (V)	60V

Isc PV (Absolute Max.) (A)	25 A
Operating Range (V)	16V-60V
Max. Input Current (A)	14A*2
Mppt Voltage Range (V)	22V-50V
Output Data (AC)	
Nominal Voltage (Vac)	220V/230V
Voltage Range (Vac)	189V-260v
Current (Max. continuous) (A)	3.63A
Frequency (Hz)	50Hz/60Hz
Frequency Range (Hz)	47.5-52.5Hz/57.5-62.5Hz
Power (Max. continuous) (W)	800W
Power Factor /Rated(default)	+/-0.90
Total Harmonic Distortion	<3%
Maximum Units Per Branch(12AWG Cable)	NA
Efficiency	
Peak Efficiency	96.8%
MPPT Efficiency	99.9%
Nighttime Power Consumption	<100mW
Features	
Communication	PLCC (Power Line Carrier Communication) / Wi-Fi
Compliance	VDE-AR-N 4105, IEC/EN61000, IEC/EN62109-1/2, EN50549-1/2019, TOR 2019, C10/11:2019, CEI 0-21, UTE C15-712-1:2013,

	VFR 2019 (See individual datasheet for specific product certifications)
Warranty	15 Years (20 years optional)
Others	
Ingress Protection (IP)	IP 67
Protective Class	Class I
Temperature(°C)	-40°C to +65°C
Relative Humidity	0%~98%
Overvoltage Category	OVC III (AC Main), OVC II (PV)
Inverter Isolation	<input checked="" type="checkbox"/> High Frequency Isolated
Weight	4.1kg
Dimensions (W*H*D)	264mm*194mm*35.5mm

4. Packing Checklist

4.1 Accessories

After you receive the Envertech microinverter, please check if there is any damage on the carton, and then check the inside completeness for any visible external damage on the microinverter and accessories. Contact your dealer if anything is damaged or missing.

4.2 Product Description

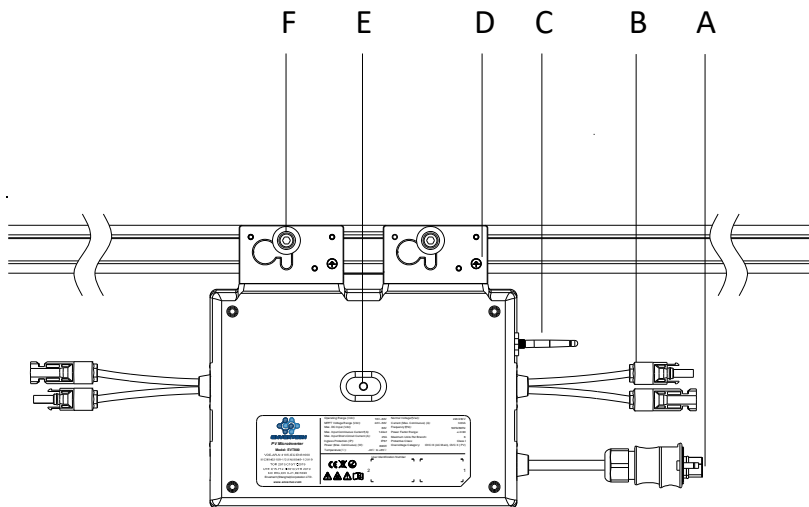







Item	Description
A	AC Connector
B	DC Connectors
C	L-type Antenna
D	Grounding Screw
E	LED Light
F	Wall Bracket Hole





4.3 Further Information

If you have any further questions concerning accessories or installation, please check our website www.envertec.com or send an email to tech@envertec.com.

4.4 Symbols on Inverter

Symbol	Description
	Dangerous electrical voltage This device is directly connected to public grid, thus all work related to the inverter shall only be carried out by qualified person
	NOTICE, danger! This device directly connected with electricity generators and public grid
	Danger of hot surface The components inside the inverter will release a log of heat during operation. DO NOT touch aluminum casing during operating.
	An error has occurred Please go to Chapter 8 "Trouble Shooting" to repair the error.
	This device SHALL NOT be disposed of in residential waste. Please go to Chapter 10 "Recycling and Disposal" for proper treatments.
	No unauthorized perforations or modifications Any unauthorized perforations or modifications are strictly forbidden. If any defect or damage (device/person) is occurred, Envertech shall not take any responsibility for it.

4.5 Accessories

PV Module	Module	
AC Extension Cable	To connect the AC side to the grid.	
AC End Cap	To seal the end of unused AC cable.	
AC Connector	Connect the microinverter's AC side to the extension cable.	

5. Microinverter System Installation



WARNING

Only qualified personnel may connect the Envertech microinverter to the utility grid after receiving prior approval from the electrical utility company.

Installing Envertech microinverter system involves several key steps. Each step listed here is elaborated on the following pages.

- Step 1. Verify voltage
- Step 2. Mount microinverters onto the rack
- Step 3. Ground the system
- Step 4. Install a Wi-Fi antenna
- Step 5. Fasten AC cables
- Step 6. Connect to the grid
- Step 7. Connect PV modules to microinverters
- Step 8. Switch on the PV system
- Step 9. WI-FI Configuration

Step 10. Monitoring through EVT800



WARNING

You must install the microinverter system under connection neither to the grid nor to the PV modules (or if not disconnected, the modules should be shaded).



WARNING

Installation could only be implemented when the system is disconnected from the grid, and the solar panel has been covered or disconnected.

Step 1. Verify that grid voltage and PV panel voltage are matching with microinverter rating

Step 2. Mount microinverters onto the rack

Mark out the estimated center of each PV module on the rack to facilitate locating microinverters.

Mount all microinverters under modules to avoid rain and sun, with the trademark facing downward.

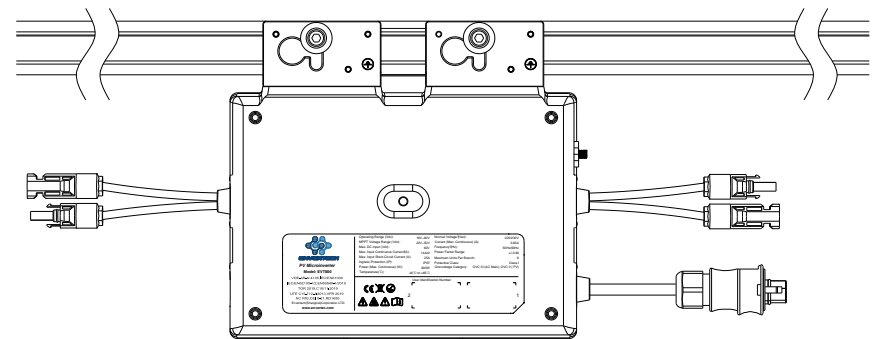

Step 3. Ground the system

Microinverters and modules must be connected to the grounding conductor in accordance with national standards. Fix the screws to the microinverter installation hole. Make sure that the grounding screw thread is pierced into the bracket to get the best grounding effect.

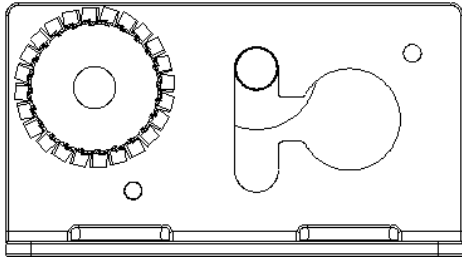

Step 4. Install a Wi-Fi antenna

For better Wi-Fi signal, rotate the antenna clockwise until it is firmly secured to the EVT800.

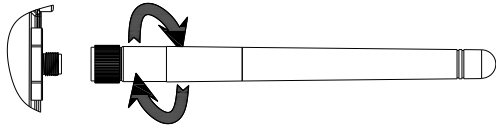

Step 5. Fasten AC cables

Fasten AC cables and grounding cables to the rack with cable ties.

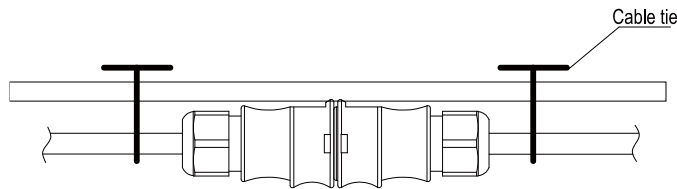

Step 6. Connect to the grid

Option a. Connect to air switch

Remove the skin of the two ends of the ex-tension cable by $y=40\text{mm}$ and remove the skin of internal wires by $x=14\text{mm}$. Set the metal terminals onto the open parts and clamp them to tighten the connection;

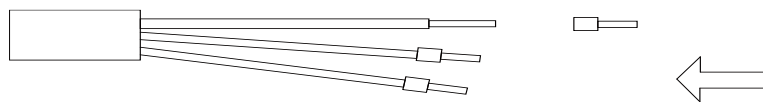
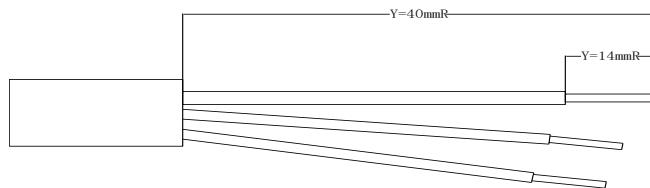

Connect the other side of the extension cable to the air switch.

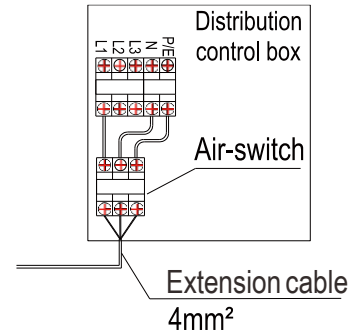

Option b. Put the open parts of the extension cable into the plug and use the plug to connect to the socket

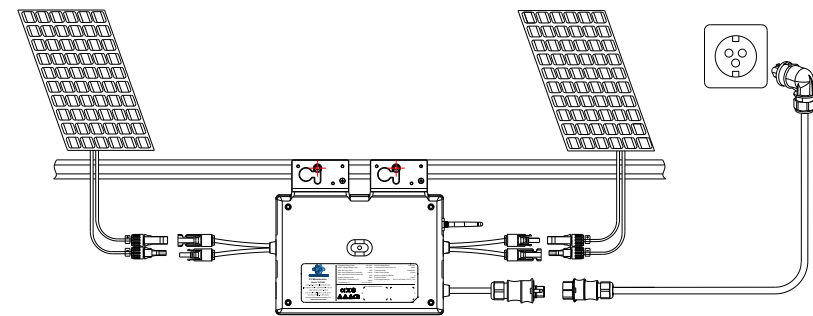

Step 7. Connect PV modules to microinverters

Mount the PV modules on top of the microinverters; Connect each PV module with the DC input cables of the microinverter.

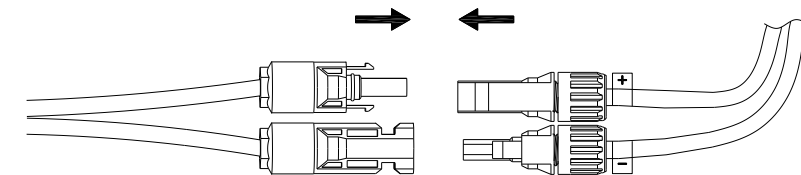

Step 8. Switch on the PV system

Ensure all connection is completed and then turn on the air switch.

For the monitoring system (EnverBridge) installation please scan this QR code .



EnverBridge Installation

Step 9. WI-FI Configuration

Option 1. Use EnverView app to configure Wi-Fi

Note: Please place the EVT800 as close as possible to the router.

The EVT800 has built-in WI-FI modular which is able to connect the router directly.

Web Portal address: <https://www.envertecportal.com/>

To access our application, you can scan the **QR code** provided below or search for 'EnverView' on Google Play Store or Apple Store for download.



EnverView App

a. Open EnverView app and click Wi-Fi. Select “EVT” to connect.

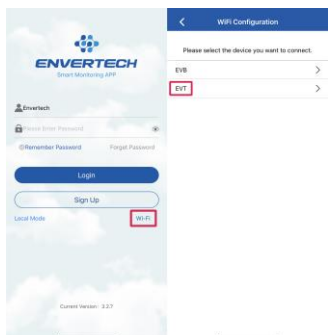

b. Select a 2.4GHz Wi-Fi network, and return to the app. Then enter the password

of 2.4GHz Wi-Fi network. Please allow EnverView app to use your location. Or you will fail to configure Wi-Fi.

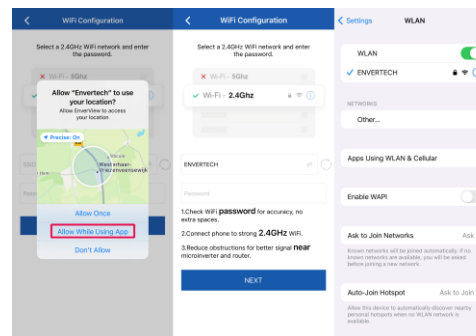

Note:

1. Please carefully check the Wi-Fi password, such as extra spaces.
2. Ensure that the Wi-Fi name and password do not contain , ; = or other special characters.
3. Please ensure that the current network your phone connect to is 2.4GHz Wi-Fi, and the connection between your router and the Internet is in good condition.

c. Connect the network whose name is as same as your EVT’s SN, and return to the app. Please allow EnverView app to find and connect to devices on your local network. If not, it also causes configuration failure.



Note: When configuring Wi-Fi, make sure you keep staying on the current connection.

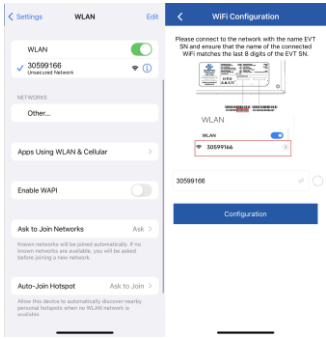

d. Click Configuration and wait for success.

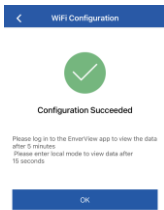

Note: If the setting is not successful, wait 5 seconds. Click Configuration again and check that the EVT800 is as close to the router as possible.

Option 2. Use computer to configure Wi-Fi

1. Go to your computer's WLAN setting. Connect a network of the same name as your EVT microinverter Serial Number.

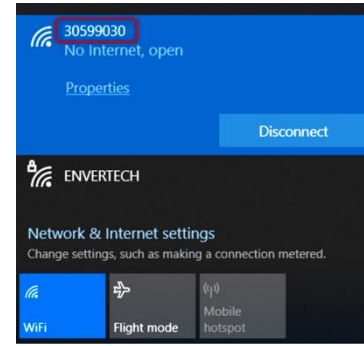

2. Use a browser to open the webpage: <http://10.10.100.254> . Log in to the account with the credentials below. Username: admin Password: admin

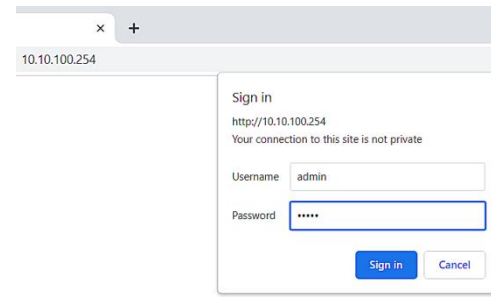

3. Click "STA Setting" for the relevant configuration, and click "Scan" to scan the WI-FI.

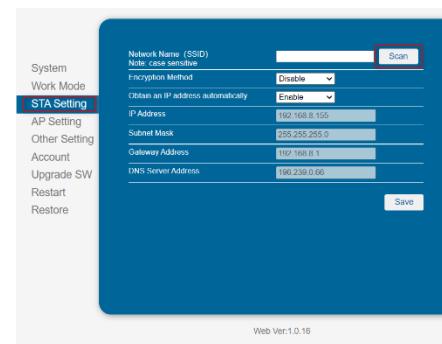

4. Select the current wireless network, and press "OK".

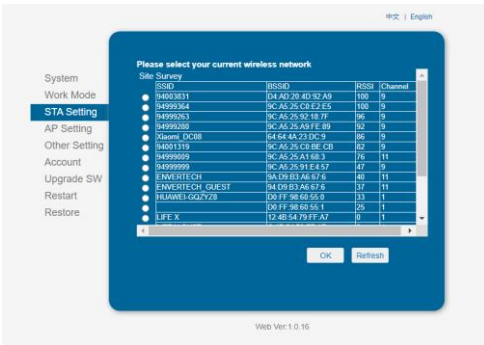

5. Fill in the corresponding Wi-Fi password and press "Save".



6. After the above operation, click "Restart". It will restart after 5 seconds.



7. The webpage will prompt "Rebooting Successful!".

Note: Don't forget the password, otherwise it cannot be reset!

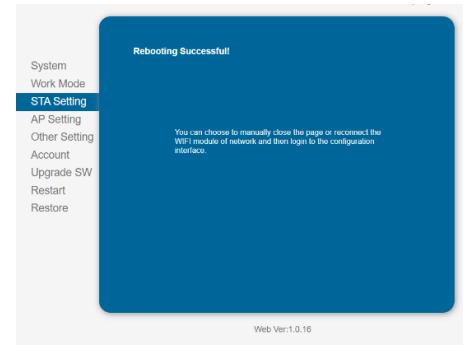

Note: If more than one microinverter needs to be connected to Wi-Fi, configure one microinverter first.

Step 10. Monitoring through EVT800

1) Register a new account by app or website.

Option 1. Visit www.envertecportal.com. Click Sign Up. Fill in the account information to finish registration.

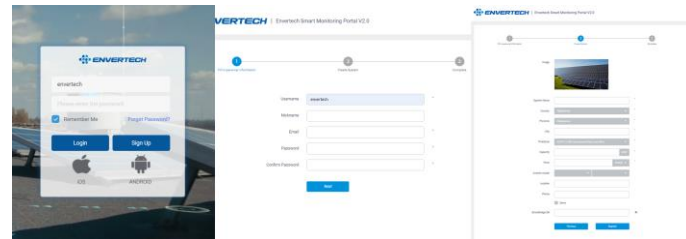

Option 2. Use the app "EverView" to register

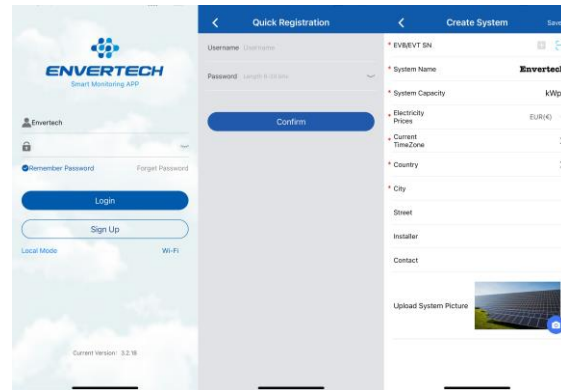

Fields marked with an asterisk (*) are required.

For Device S/N, you can find S/N labeling on EVT800 or outer packaging. Enter the last 8 digits of it or scan the corresponding barcode.

2) MI Binding

Option 1. Use EnverView app to bind MI

Step 1. Log in your account on your mobile phone. Then go to “Settings”.

Step 2. Under “Device Management”, click “+” and enter the SN of EVT800.

Step 3. Click “Confirm” to finish adding the MI.

Note: Please ensure that both EVT800 and your phone are in the same router network.

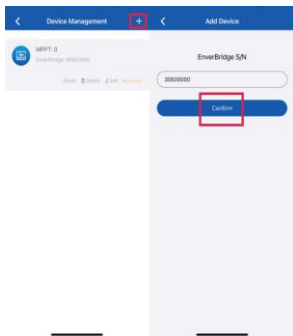

Option 2. Use EnverView app to bind MI (Local mode)

Note: Please ensure that both EVT800 and your phone are in same router network.

Step 1. Launch EnverView app, and enter Local Mode. Connect your EVT800.

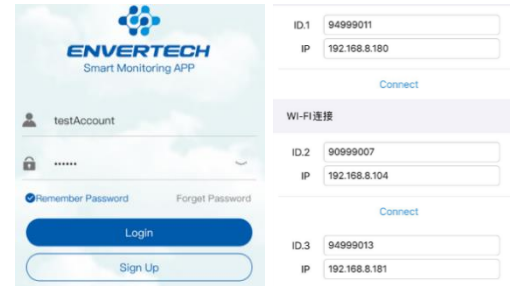

Step 2. On EVB Overview page, enter Settings. Click Add MI you could choose enter MI SN manually or click the grid icon to scan the MI SN automatically.

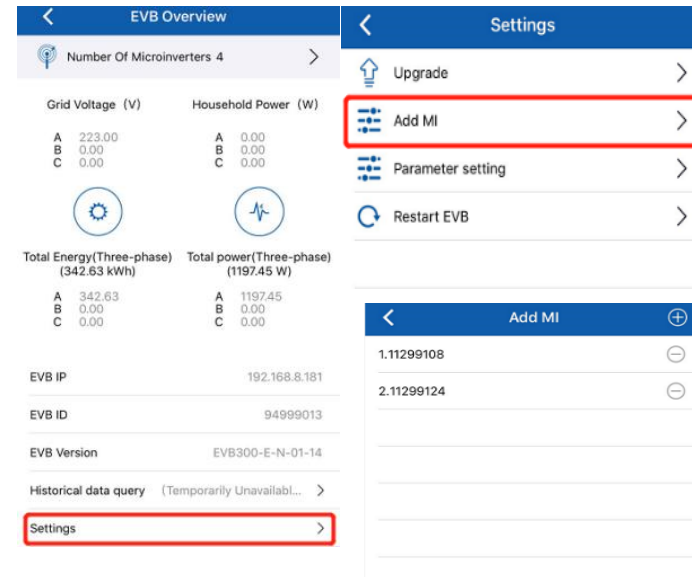

Option 3. Use EnverPortal to bind MI

a. Login www.envertecportal.com with the newly-registered account, go to Settings--Management.

b. Click Add, then enter the SN of EnverBridge, click OK to finish adding monitor.

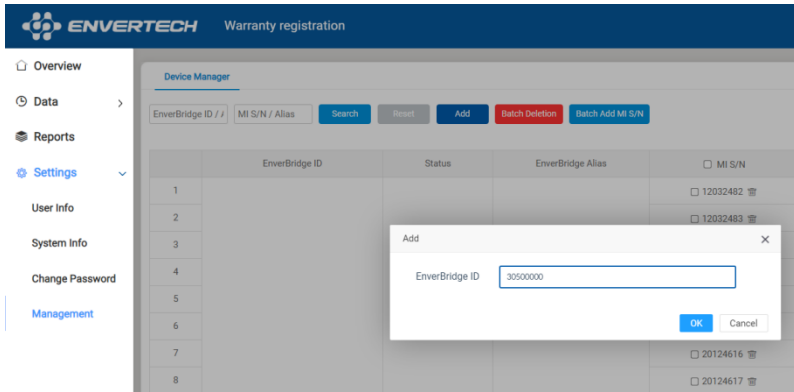

c. Click “+” button behind the EnverBridge SN, then enter the SN of the EVT800, click OK to finish binding.

Local Mode

1. Components

To use the local mode on EVB300, additional accessories should be prepared.

- EVB300 (Firmware version EVB-300-E-N-003-014 or higher)
- A USB flash drive with the sufficient storage space (format: FAT16/32 or exFAT)

2. Operating steps

Insert the USB flash drive into the USB socket on EVB300.

Note: Insert the USB flash drive into the USB socket on EVB300 as shown on the following picture. Otherwise, the USB flash drive cannot be recognized.

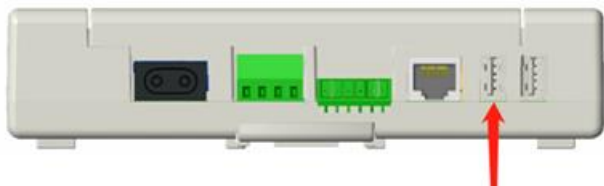

3. Installation

Once USB flash drive has been installed, the data will be recorded in USB flash drive automatically.

- 1) Enter the local history query interface

Open EnverView APP, click [Local Mode]>>> select the EVB300 SN >>> open monitoring interface >>> enter Local History Data Query Function.

Click [Time Calibration] button before use.

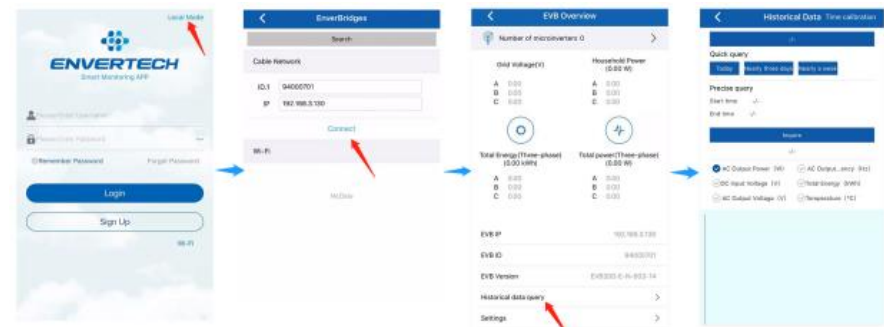

- 2) Data query

a) Introduction to the interface



- ① Time Calibration button
- ② Microinverter SN selection
- ③ Quick query button
- ④ Start time and End time selection
- ⑤ Inquire button
- ⑥ Parameters selection
- ⑦ Curve display area



b) Quick Query

There are 3 buttons, Today, Nearly three days and Nearly a week.

Click and select the time range to get the detailed data

c) Precise Query

Click and select the time range to get the detailed data.

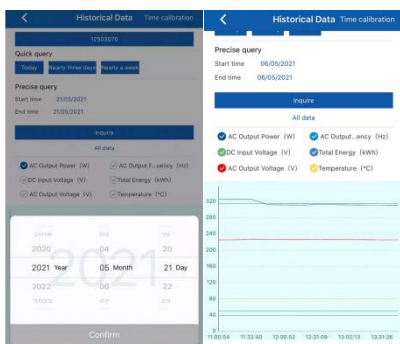

d) Others

Click and select the microinverter SN to get the data for each microinverter.

6. Debugging and Operating

Please notice the symbols.



WARNING

Only qualified personnel may connect the Envertech microinverter to the utility grid after receiving prior approval from the electrical utility company.



WARNING

Ensure that all AC and DC wiring is correct. Ensure that none of the AC and DC wires is twisted or damaged.

6.1 Energize the System

1. Turn on the switch or the circuit breaker at each microinverter AC branch.
2. Turn on the main AC circuit breaker in the distribution box. Your system will start to produce power after 3 minutes.
3. Envertech microinverters begin to communicate through the power lines to EnverBridge. The entire system will be detected within 10 minutes.

4. The voltage and frequency of EVT800 can be adjusted on the site. If adjustments are required by your local utility company, installers can use EnverBridge to manage grid parameters after all microinverters have been detected.

6.2 EVT800 Operation

The Envertech microinverter is powered on when there is sufficient DC voltage from the PV module. The LED light of each microinverter will blink green to indicate normal start-up operation approximately 1 minute after DC power is applied.

7. Troubleshooting and Maintenance

Adhere to all the safety measures described throughout this manual. If the PV system does not operate correctly, the following troubleshooting measures can be applied by qualified personnel.



WARNING

Do not attempt to repair the Envertech microinverter. It contains no user-serviceable parts. If the microinverter fails, contact your direct supplier or Envertech customer service to obtain an RMA (return merchandise authorization) number and start the replacement process.

7.1 LED Status Indications and Error Report

LED Startup:

The LED of each microinverter blinks red for a while at the beginning, and then blinks green to indicate normal start-up approximately 10 seconds after DC power is applied. If the LED blinks red after DC power is on, it indicates a failure during the start-up.

Post-Startup LED Indications:

Check LED status to confirm the present situation.

Flashing Green: It indicates normal operation.

Flashing Red:

1. If red light flashes every 2 or 3 seconds, it indicates that the microinverter is waiting for sun or prepare to produce energy.
2. If red light flashes continuously, it indicates that the microinverter is not operating normally. The microinverter does not detect that the utility grid is within operable voltage/frequency range. The microinverter cannot produce power until this is solved.

7.2 Troubleshoot an Inoperable Microinverter

To troubleshoot an inoperable microinverter, follow the steps in the order shown below.

WARNING: Be aware that only qualified personnel should troubleshoot the PV array or the Envertech microinverter.

Best Practice: Please do not disconnect DC connection while the system is working. Ensure that no current is flowing in the DC wires prior to disconnecting. If necessary, use an opaque to cover the PV module prior to disconnecting the PV module. Always disconnect AC power before disconnecting the PV module from the Envertech microinverter. Disconnecting AC connectors of the microinverters is also a means of cutting off AC power.

WARNING: The AC and DC connectors on the cabling are rated as a disconnecting point only when used with an Envertech microinverter.

WARNING: Envertech microinverters are powered by DC power from the PV modules. Please disconnect and reconnect DC power to check the LED blinks 1 minute after DC is applied.

1. Make sure AC breakers are on.
2. Check the connection to the utility grid and verify that the grid voltage is within allowable ranges shown in the Technical Data section.
3. Verify that AC voltage at all solar power circuit breakers of the load centers are within the ranges shown in the following table.

4. Verify that AC line voltage at the junction box for each AC branch circuit is within the ranges required by local grid standards.

Single-Phase 230 VAC		Three-Phase 230 VAC	
L to N	189 to 260VAC	L1 to L2 to L3	310 to 460VAC

5. Confirm if the microinverter side is connected to the grid by measuring the voltage from AC line to line and line to neutral.

6. Visually check if AC branch circuit connection is correctly done. Reinstall if necessary. -Check also for damage, such as rodent damage.

7. Make sure that all circuit breakers are off.

8. Disconnect and re-connect the PV modules' DC connectors with microinverters. The LED status of each microinverter will blink green to indicate normal start-up operation soon after DC power is applied (less than one minute).

9. Attach an ammeter clamp to one conducting wire of the DC cables from the PV module to measure the microinverter's current. This will be under 1 Amp if AC is disconnected.

10. Check the DC connection between the microinverter and the PV module. The connection may need to be tightened or reseated. If the connection is worn out or damaged, it needs replacement.

11. Verify with your utility company that grid frequency is within the regulated range.

7.3 Disconnect Microinverters from PV Modules

If your problems are still unsolved with the steps above, please contact Envertech tech support through www.envertec.com. If Envertech approves the replacement, please take off the microinverter according to the following

instructions. In order to ensure the disconnection between the microinverter and the PV Module will not be done while the microinverter is at working status, please strictly follow the steps below.

1. Turn off AC branch circuit breaker.
2. Disconnect the microinverters in the following procedure.

Pull the AC connectors of both sides of the microinverters in the opposite direction with appropriate force.

3. Cover the PV module with an opaque, and then disconnect the PV module DC connectors from the microinverter.
4. Loosen the grounding screw and remove the grounding wire.
5. Take off the microinverter from the PV frame.

8. System Diagram

1. Single phase

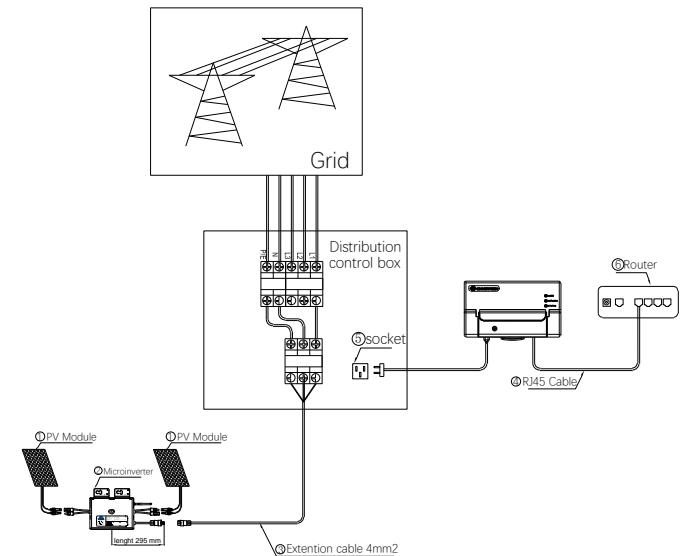



WARNING:

Do not attempt to repair the Envertech microinverter. It contains no user-serviceable parts. If the microinverter fails, contact your direct supplier or Envertech customer service to obtain an RMA (return merchandise authorization) number and start the replacement process.

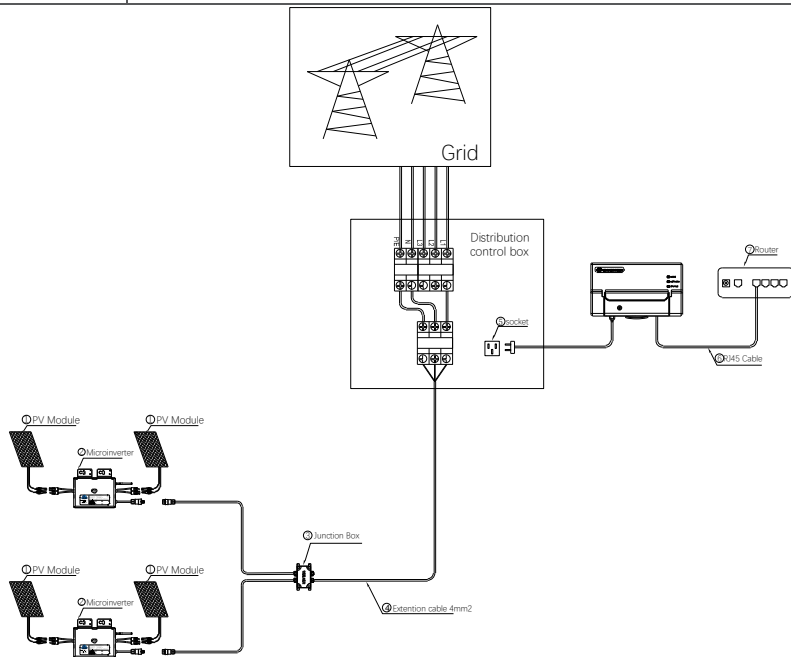

2. Three phase

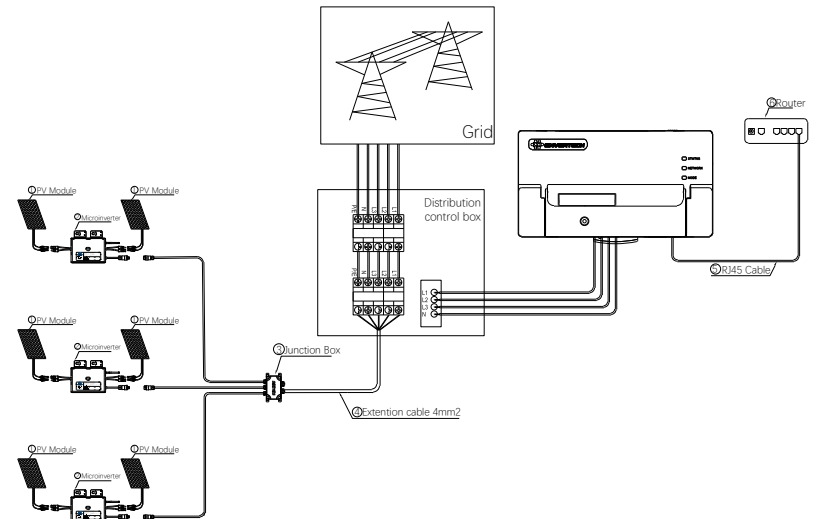

Unscrew the front cover with the complimentary hex screwdriver, then plug wires on each phase into the corresponding connector of EVB300.

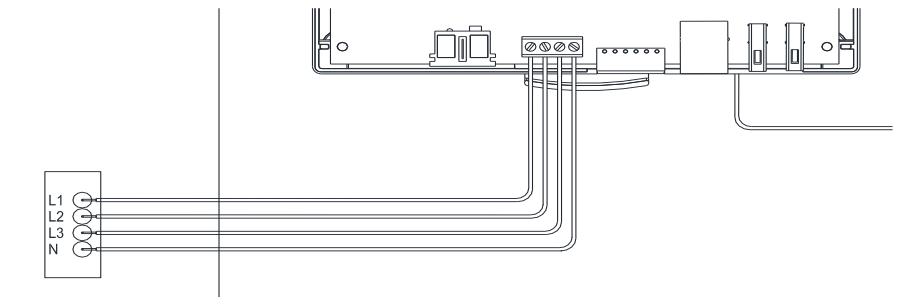

9. Recycling and Disposal

In order to comply with the regulations on recycling management of electrical and electronic wastes in various countries, electrical equipment's that have reached its lifetime must be collected separately to the unit or individual that

has obtained the qualification for disposing discarded electrical and electronic products. For any equipment that you no longer use, please return it to your dealer for recycling, or send it to an approved recycling unit in your area for recycling.

10. Contact

Envertech Corporation Ltd.

Tel: +86 21 6858 0086

Web: www.envertec.com

Email: info@envertec.com

Add: No.138, Xinjunhuan road, Minhang District, Shanghai, China